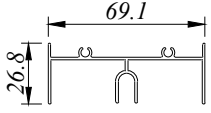
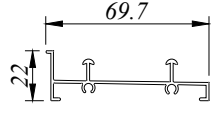
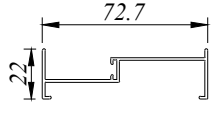
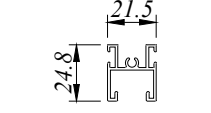
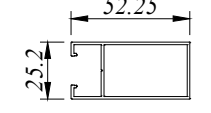
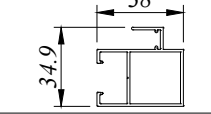
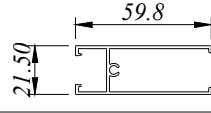
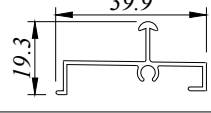
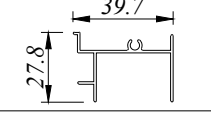
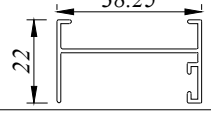
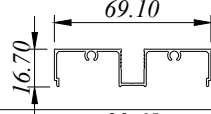
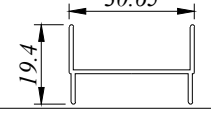

ESD

Economic Sliding Door

42 SERIES

PROFILE NO.	PICTURE OF PROFILE	WEIGHT (KG/M) AREA PERIMETER (MM)			PACKING IN BUNDLE (PCS)
		D 1.00 MM	H 1.20 MM	J 1.30 MM	
ESD 4201		0.496 344.224	0.618 343.336	0.679 344.069	6
ESD 4202		0.450 296.251	0.511 293.825	0.541 296.095	6
ESD 4203		0.382 271.080	0.455 269.536	0.492 271.080	10
ESD 4204		0.300 208.352	0.350 207.266	0.425 207.435	12
ESD 4205		0.457 206.547	0.536 205.205	0.576 206.547	10
ESD 4206		0.446 227.573	0.527 225.173	0.568 227.573	12
ESD 4207		0.483 320.319	0.580 317.425	0.628 320.319	6
ESD 4208		0.258 160.464	0.280 160.500	0.291 160.385	12
ESD 4209		0.325 212.454	0.354 211.75	0.393 212.119	12
ESD 4210		0.289 189.866	0.314 187.53	0.355 189.738	12
ESD 4212		0.451 298.662	0.492 298.860	-	6
ESD 4217		0.183 134.928	-	-	12

All Profiles are standard length 6.1 M for ESD Series except ESD 4203, ESD 4205, & ESD 4206 which is 4.34M or 4.88M

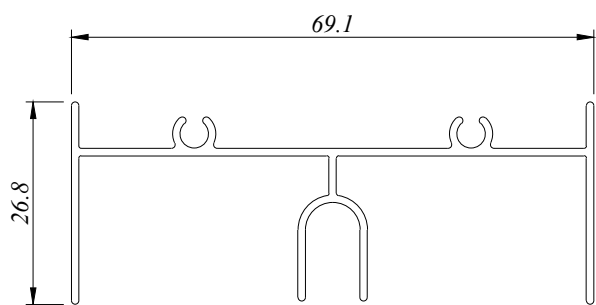

ESD 4201 D
0.496 Kg/M
AP : 344.224 MM

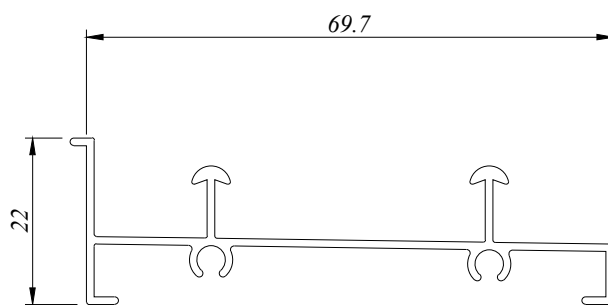

ESD 4202 D
0.450 Kg/M
AP : 296.100 MM

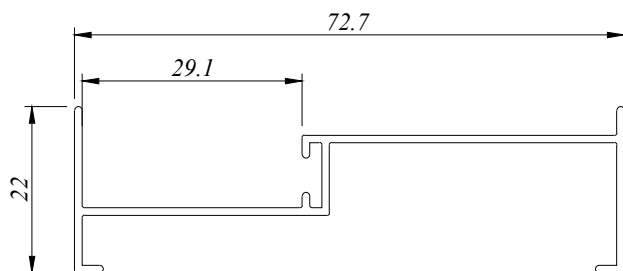

ESD 4203 D
0.382 Kg/M
AP : 271.080 MM

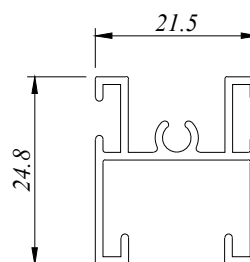

ESD 4204 D
0.300 Kg/M
AP : 208.352 MM

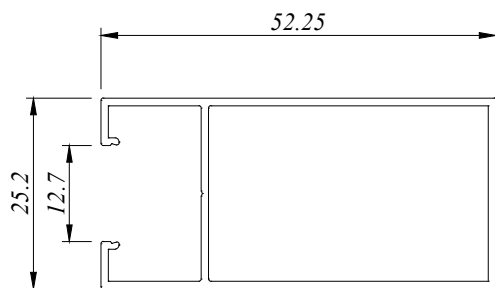

ESD 4205 D
0.457 Kg/M
AP : 206.547 MM

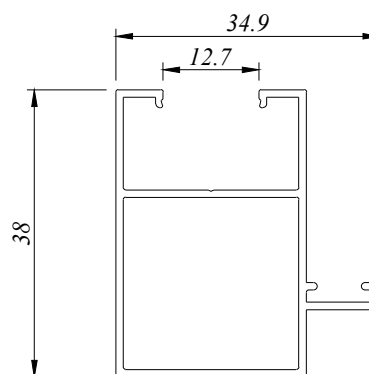

ESD 4206 D
0.446 Kg/M
AP : 227.573 MM

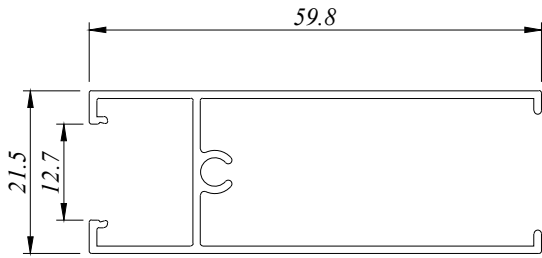

ESD 4207 D
0.483 Kg/M
AP : 320.319 MM

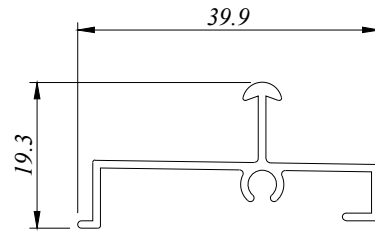

ESD 4208 D
0.258 Kg/M
AP : 160.464 MM

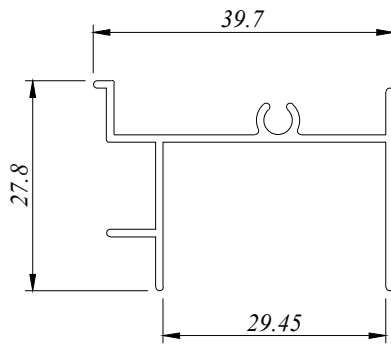

ESD 4209 D
0.325 Kg/M
AP : 212.454 MM

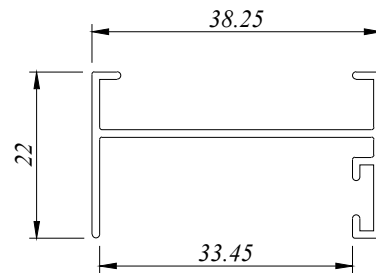

ESD 4210 D
0.289 Kg/M
AP : 189.866 MM

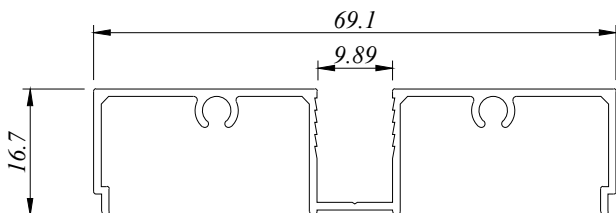

ESD 4212 D
0.451 Kg/M
AP : 298.662 MM

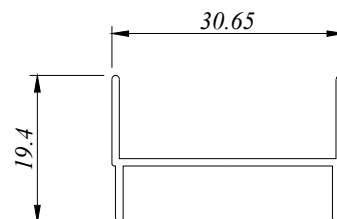

ESD 4217 D
0.183 Kg/M
AP : 134.926 MM

aluminium profiles component usage

Economic Sliding Door - ESD 42 Series

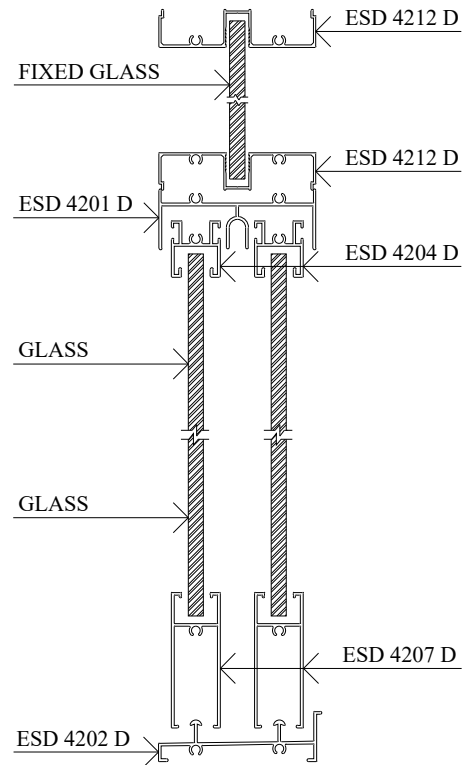
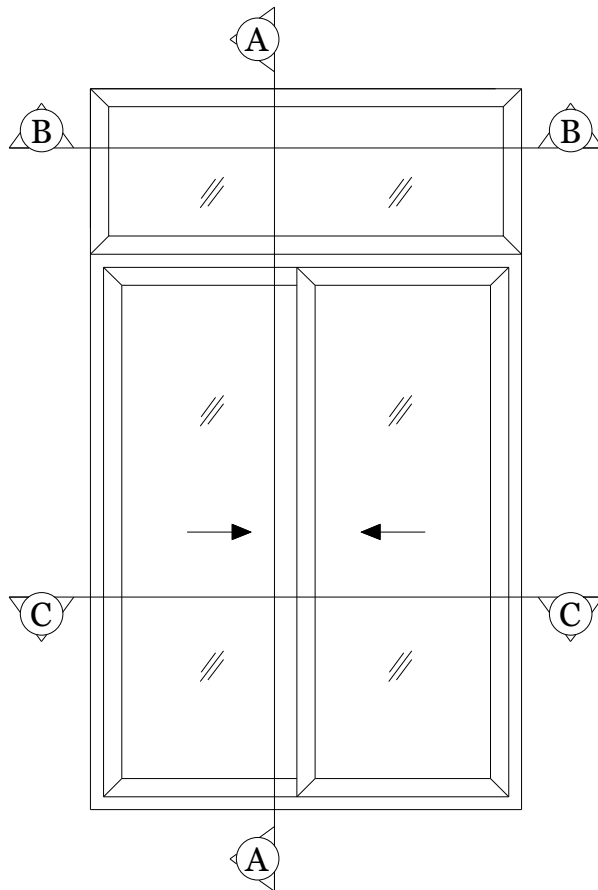

SECTION VIEW A - A

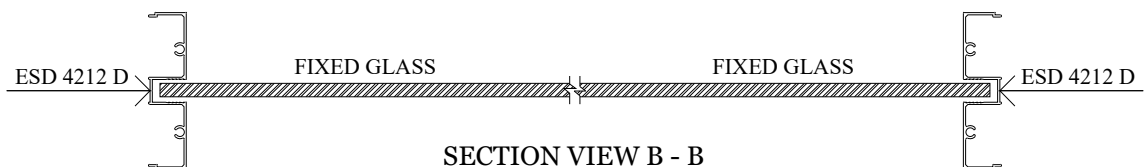

SECTION VIEW B - B

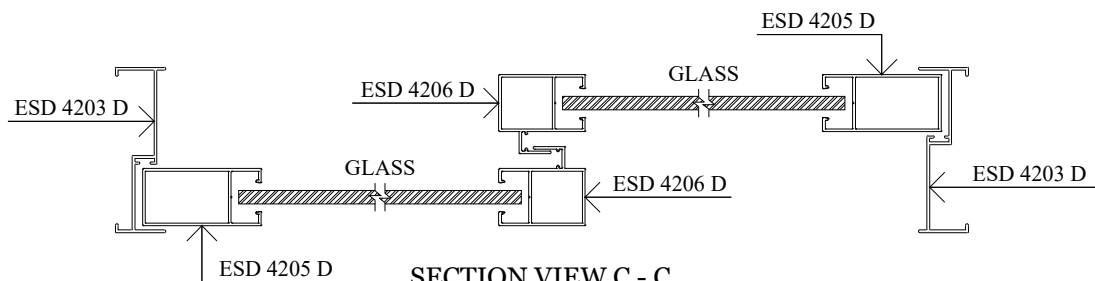

SECTION VIEW C - C



BP Aluminium Extrusion Sdn. Bhd.

**No.15 & 16, 1C KKIP Selatan, Industrial Zone 2, KKIP,
88450, Jalan Sepanggar, Menggatal.**

t : 60-88-499333, 499111 f : 60-88-499222

b_p_a_@yahoo.com