

*ACW - Casement Window*

*385/386 SERIES*

PROFILE NO.	PICTURE OF PROFILE	WEIGHT (KG/M)	THICKNESS	PACKING IN BUNDLE (PCS)
			AREA PERIMETER	
ACW 3851		0.184	1.00 MM 137.945 MM	20
ACW 3852		0.489	1.30 MM 293.135 MM	6
ACW 3852 L		0.588	1.50 MM 286.714 MM	6
ACW 3853		0.797	1.30 MM 294.516 MM	4
ACW 3853 L		0.939	1.50 MM 288.113 MM	4
ACW 3854		1.127	1.20 MM 344.559 MM	2
ACW 3855		1.358	1.20 MM 370.340 MM	2
ACW 3857		0.629	1.30 MM 357.722 MM	4
ACW 3858		0.752	1.80 MM 351.928 MM	4
ACW 3859		1.336	1.80 MM 606.273 MM	2
ACW 3860		1.164	1.30 MM 613.866 MM	2
ACW 3866		0.225	1.00 MM 161.313 MM	20

All Profiles are standard length 6.1 M for ACW Series

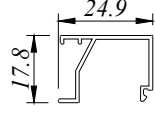
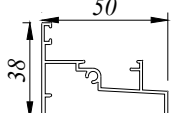
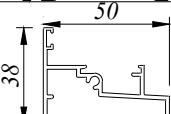
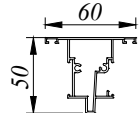
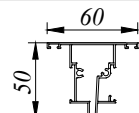
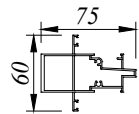
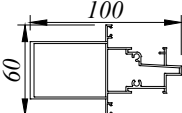
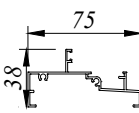
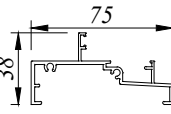
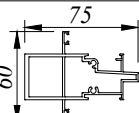
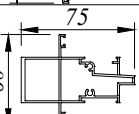
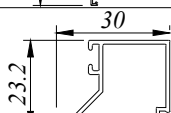
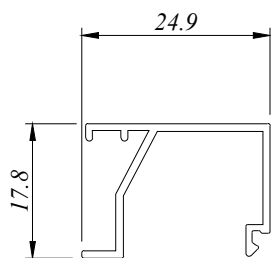

ACW 3851  
0.184 Kg/M  
AP : 137.945 MM

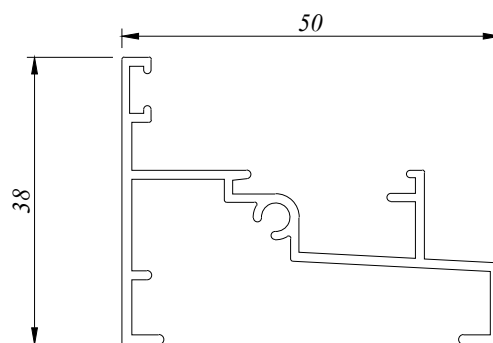

ACW 3852  
0.489 Kg/M  
AP : 293.135 MM

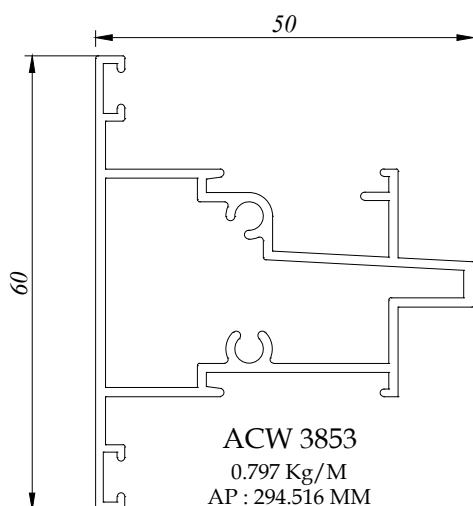

ACW 3853  
0.797 Kg/M  
AP : 294.516 MM

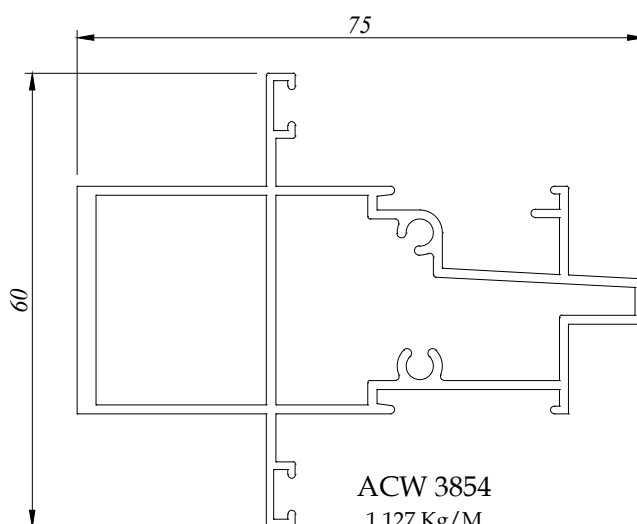

ACW 3854  
1.127 Kg/M  
AP : 344.559 MM

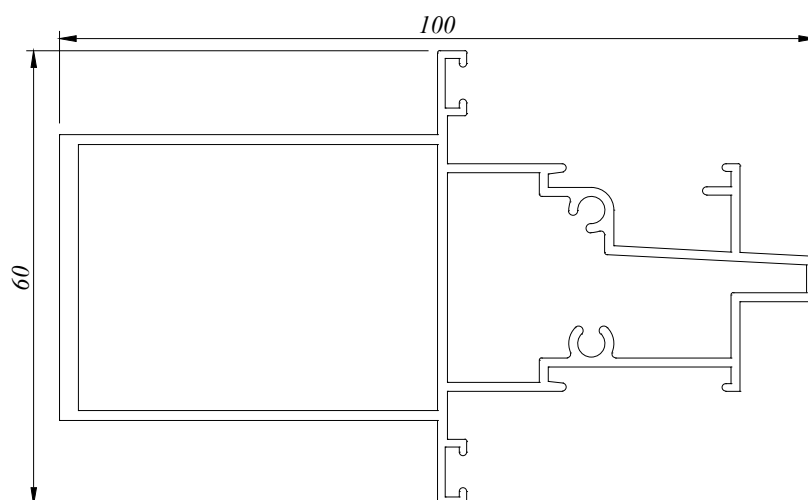

ACW 3855  
1.358 Kg/M  
AP : 370.340 MM

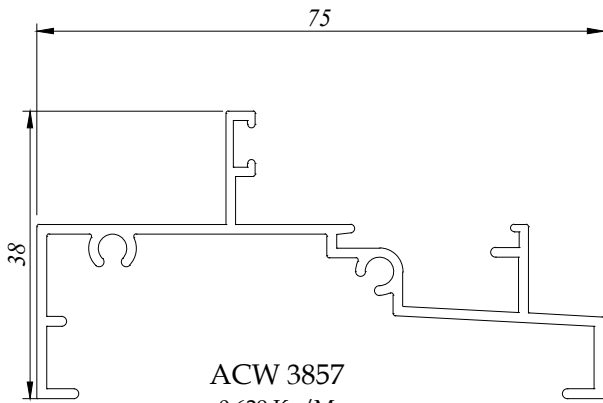

ACW 3857  
0.629 Kg/M  
AP : 357.722 MM

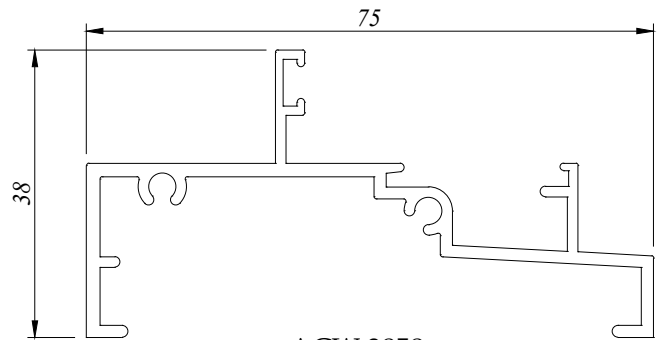

ACW 3858  
0.752 Kg/M  
AP : 351.928 MM

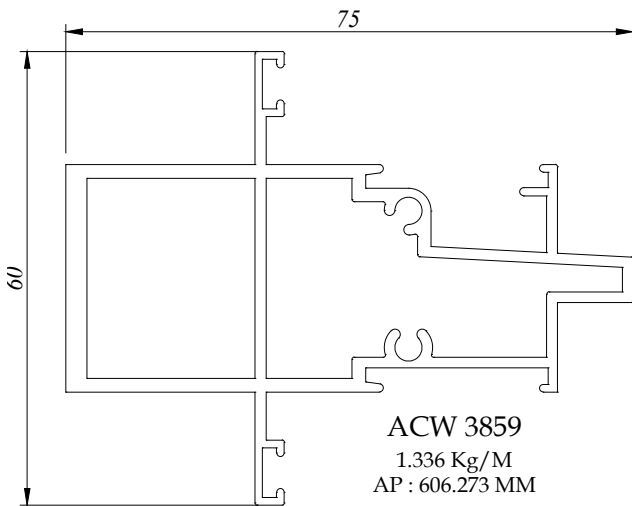

ACW 3859  
1.336 Kg/M  
AP : 606.273 MM

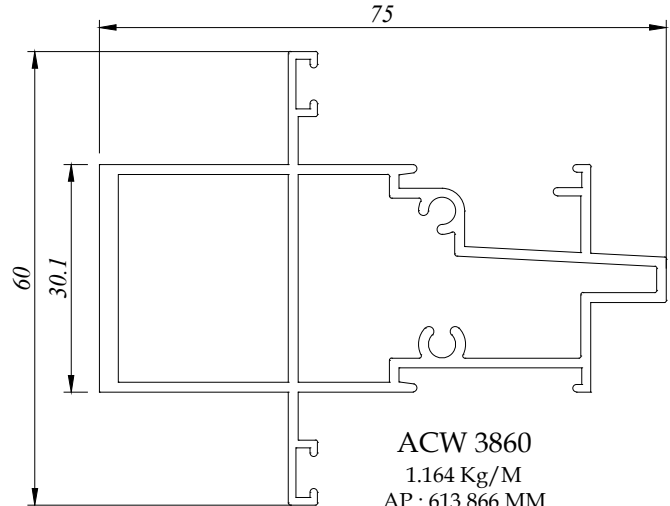

ACW 3860  
1.164 Kg/M  
AP : 613.866 MM

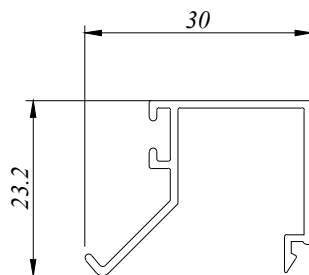

ACW 3866  
0.225 Kg/M  
AP : 161.313 MM



**BP Aluminium Extrusion Sdn. Bhd.**

**No.15 & 16, 1C KKIP Selatan, Industrial Zone 2, KKIP,  
88450, Jalan Sepanggar, Menggatal.**

**t : 60-88-499333, 499111 f : 60-88-499222**

**b\_p\_a\_e@yahoo.com**