

CTW - Curtain Wall

37 SERIES

PROFILE NO.	PICTURE OF PROFILE	WEIGHT (KG/M)	THICKNESS	PACKING IN BUNDLE (PCS)
			AREA PERIMETER	
CTW 3701		0.435	1.40 MM 233.301 MM	6
CTW 3702		0.921	1.40 MM 279.186 MM	4
CTW 3703		0.338	1.70 MM 132.098 MM	10
CTW 3704		0.177	0.70 MM 140.086 MM	20
CTW 3705		0.775	1.40 MM 138.770 MM	6
CTW 3707		0.892	1.40 MM 465.180 MM	4
CTW 3708		0.741	1.60 MM 196.630 MM	4
CTW 3709		1.772	1.80 MM 435.141 MM	2
CTW 3710		1.303	1.80 MM 340.446 MM	2
CTW 3711		1.519	1.60 MM 370.279 MM	2
CTW 3713		1.200	1.70 MM 197.210 MM	3
CTW 3714		1.228	1.80 MM 526.179 MM	4
CTW 3715		0.869	1.40 MM 248.427 MM	3

All Profiles are standard length 6.1 M for CTW Series

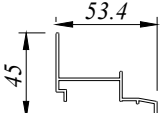
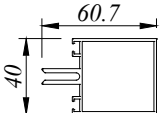
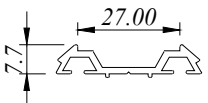
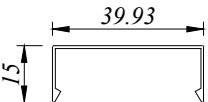
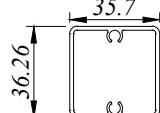
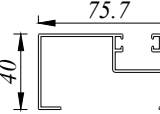
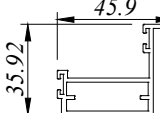
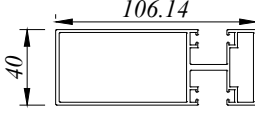
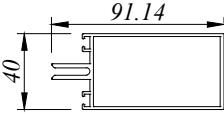
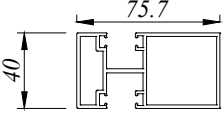
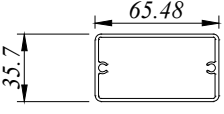
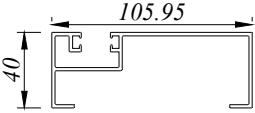
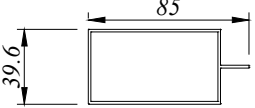
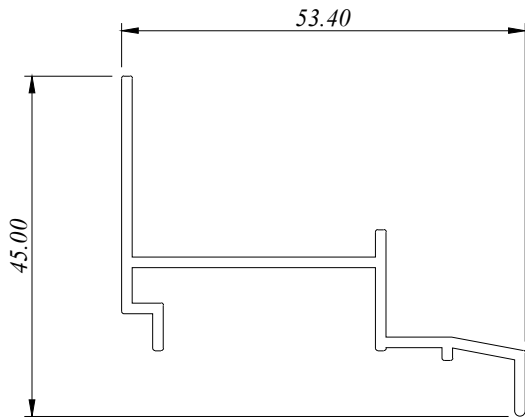

CTW 3701
0.435 Kg/M
AP : 233.301 MM

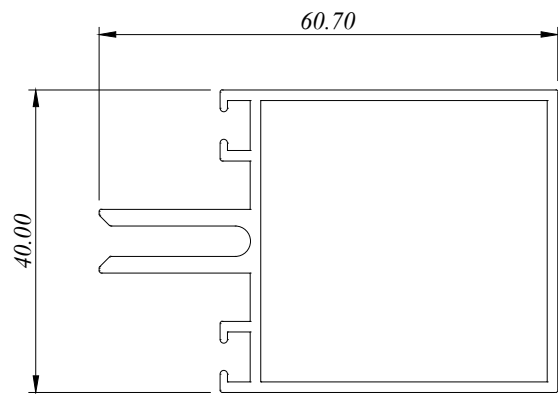

CTW 3702
0.921 Kg/M
AP : 279.186 MM

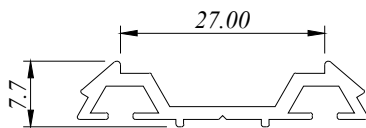

CTW 3703
0.338 Kg/M
AP : 132.098 MM

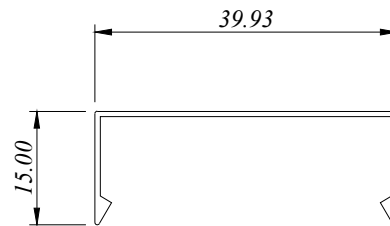

CTW 3704
0.177 Kg/M
AP : 140.086 MM

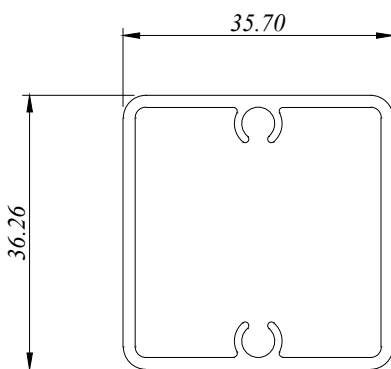

CTW 3705
0.775 Kg/M
AP : 138.770 MM

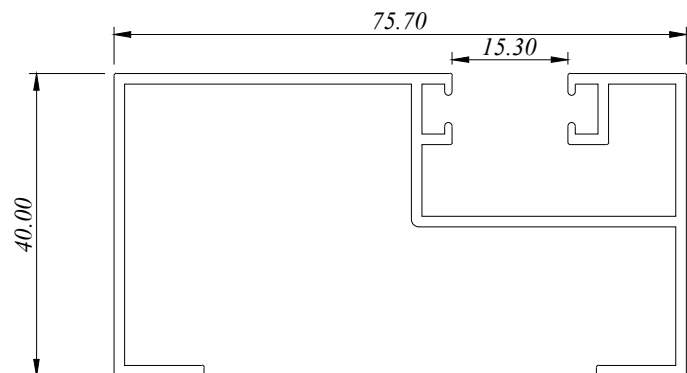

CTW 3707
0.892 Kg/M
AP : 465.180 MM

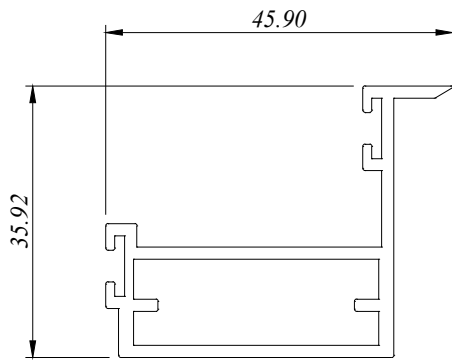

CTW 3708
0.741 Kg/M
AP : 196.630 MM

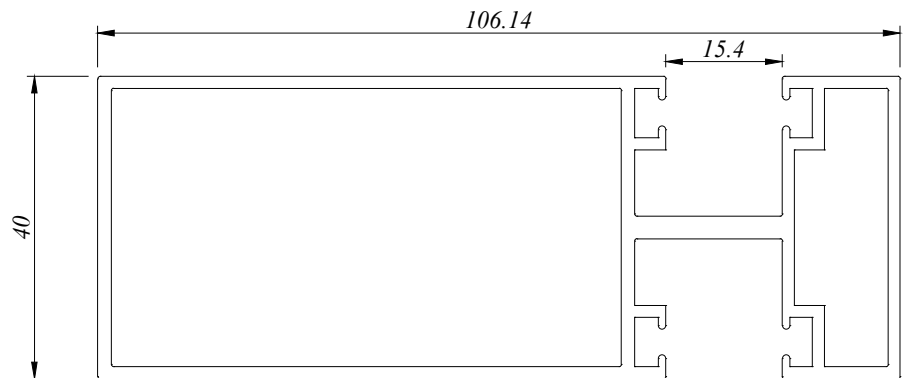

CTW 3709
1.772 Kg/M
AP : 435.141 MM

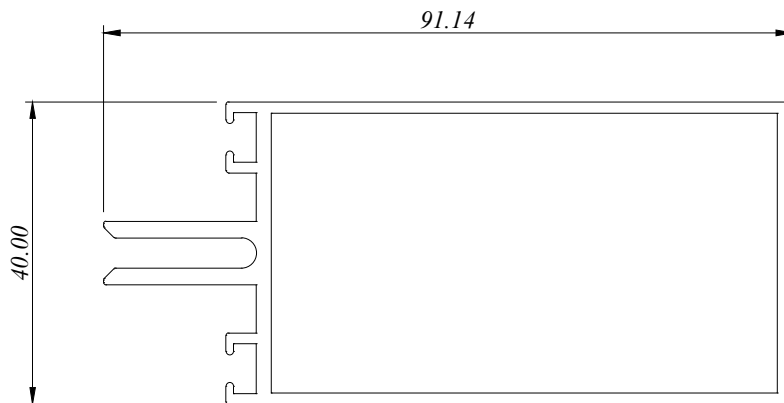

CTW 3710
1.303 Kg/M
AP : 340.446 MM

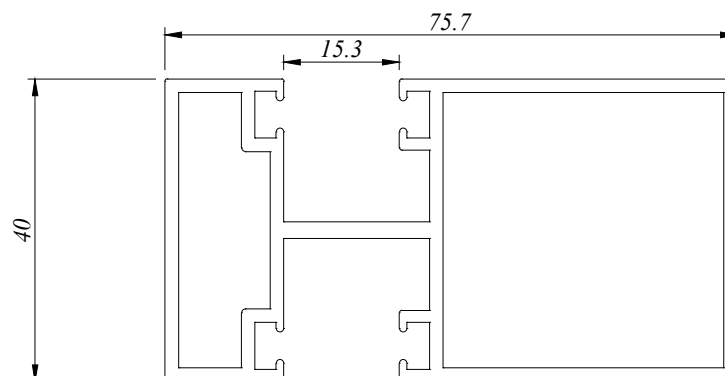

CTW 3711
1.519 Kg/M
AP : 370.279 MM

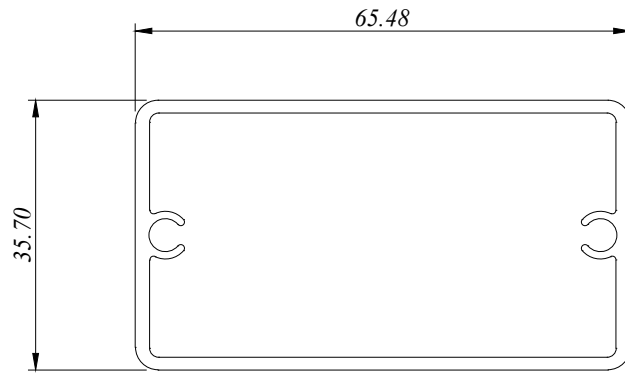

CTW 3713
1.200 Kg/M
AP : 197.210 MM

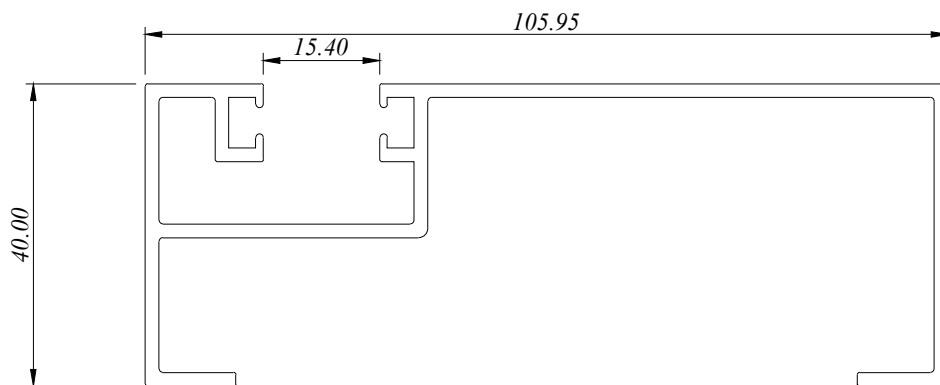

CTW 3714
1.228 Kg/M
AP : 526.179 MM

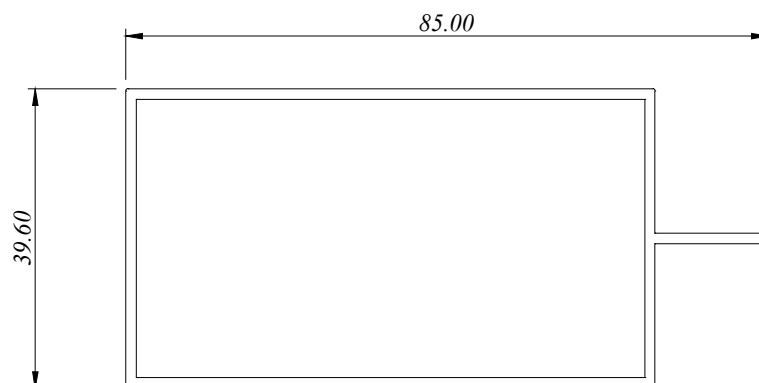

CTW 3715
0.869 Kg/M
AP : 248.427 MM

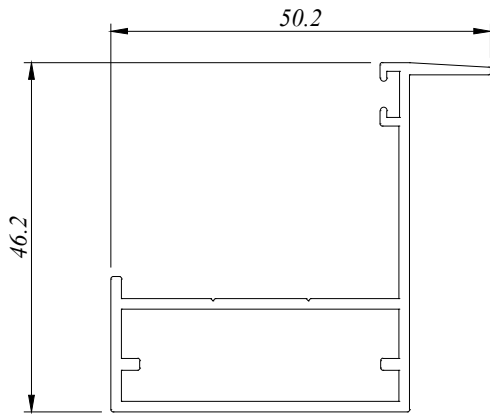

CTW 3716
0.604 Kg/M
AP : 196.650 MM

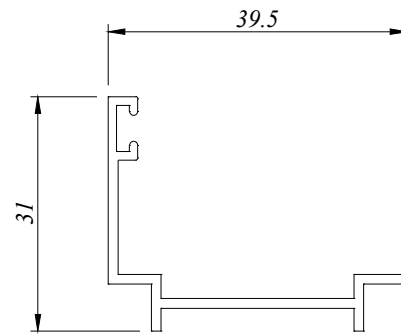

CTW 3717
0.315 Kg/M
AP : 184.541 MM

aluminium profiles component usage

Curtain Wall - CTW37 Series

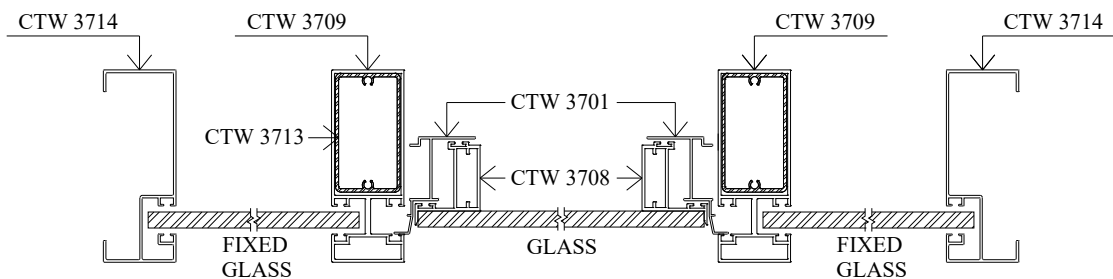
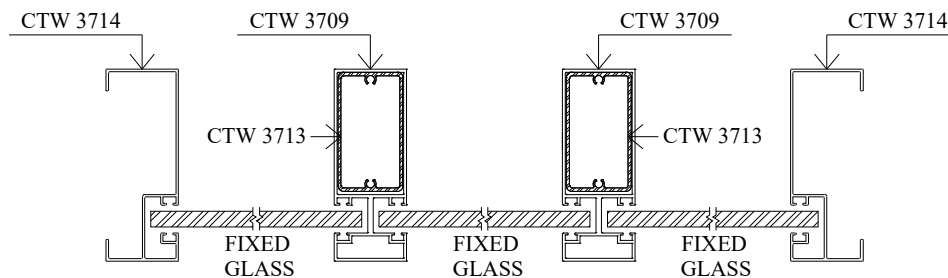
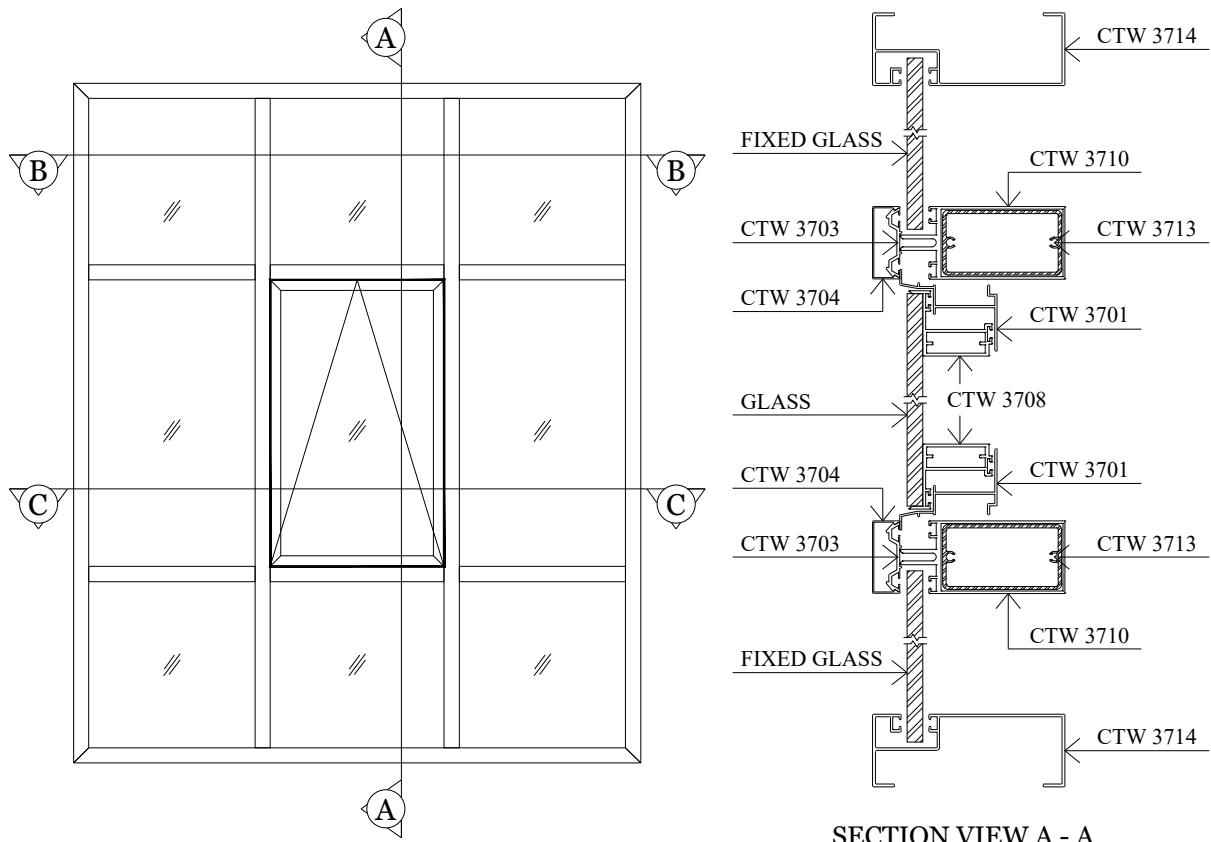

we made aluminium into shapes ...

profile information

aluminium profiles component usage

Curtain Wall - CTW37 Series

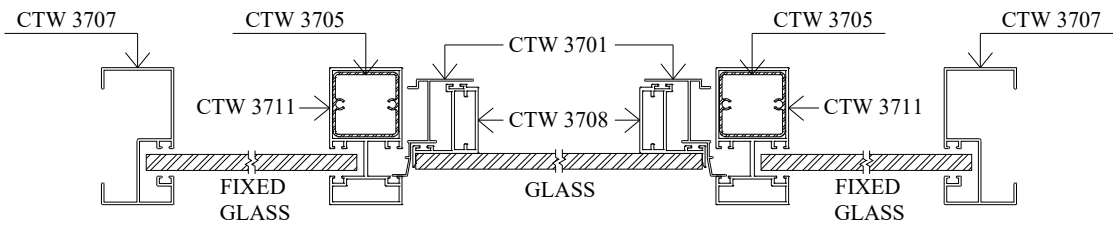
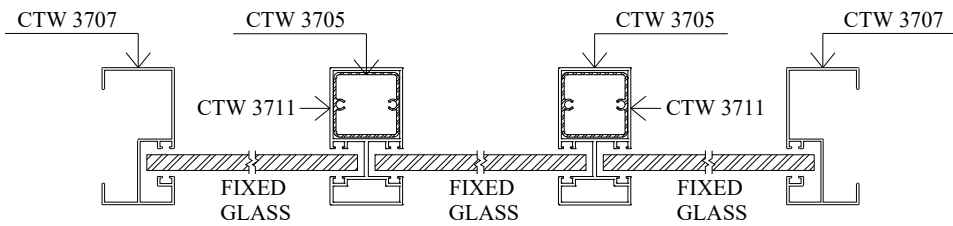
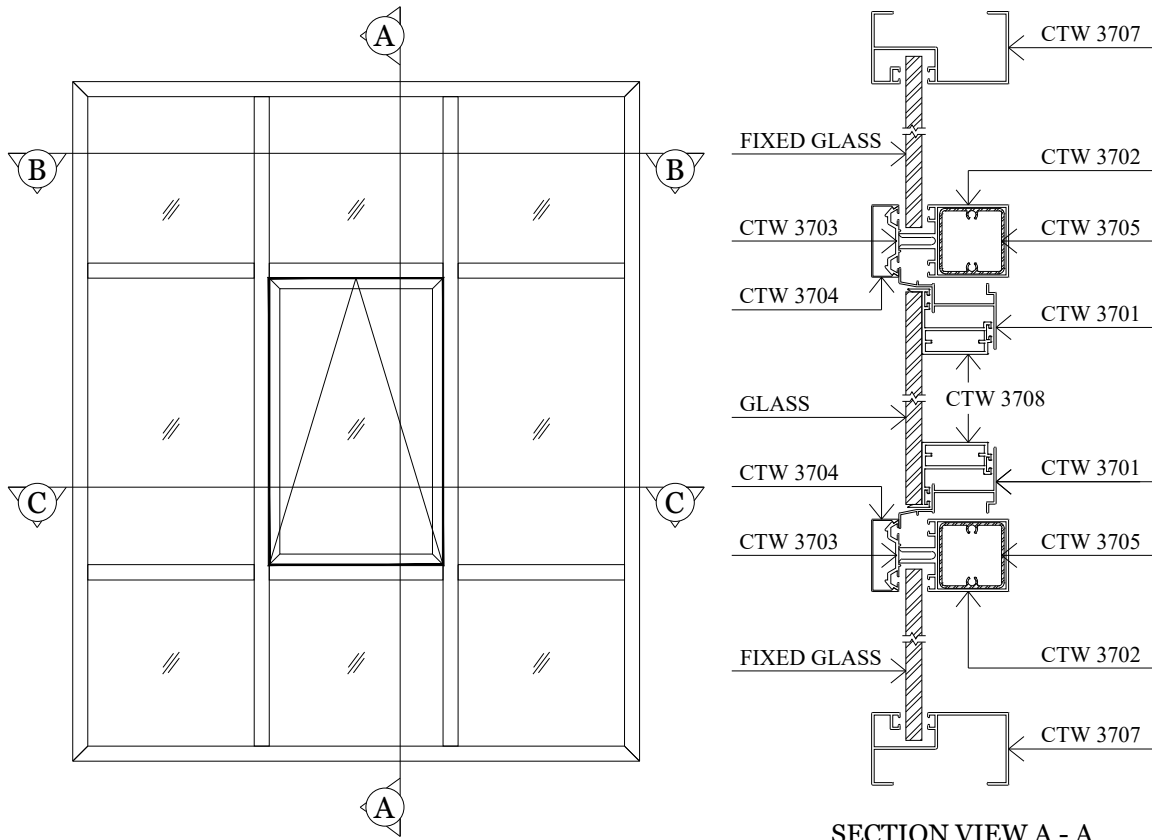

we made aluminium into shapes ...

profile information

aluminium profiles component usage

Curtain Wall - CTW37 Series

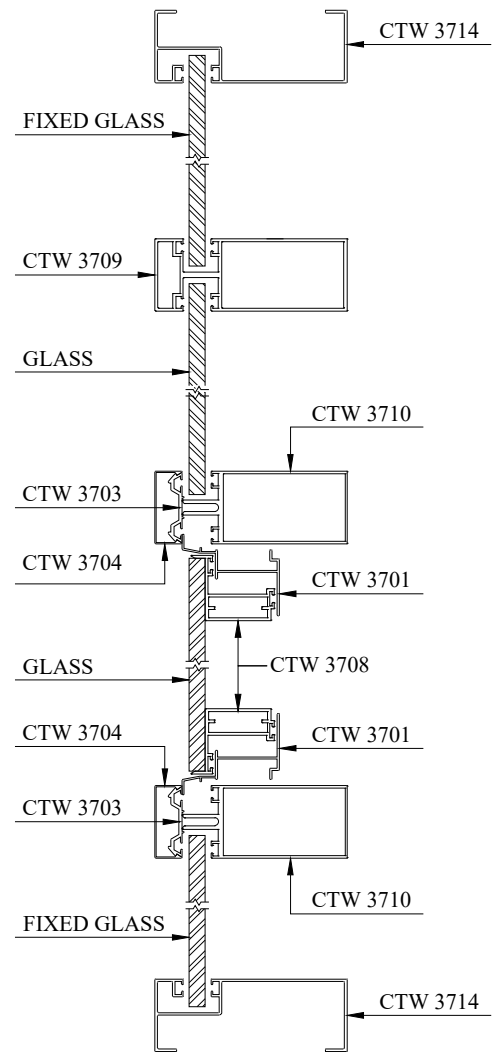
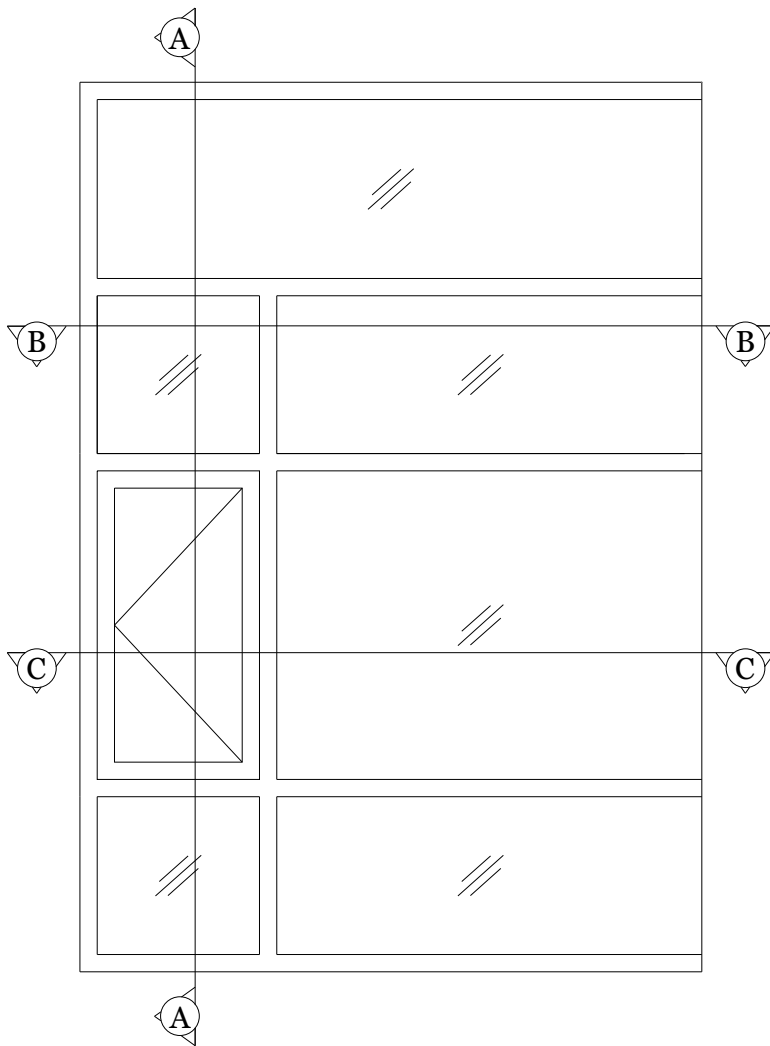

SECTION VIEW A - A

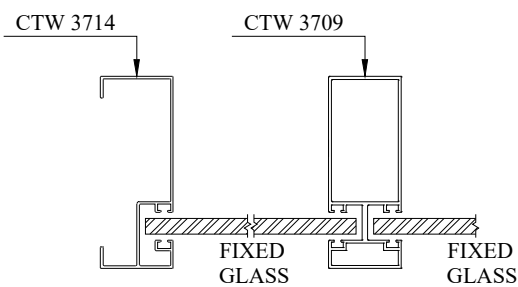

SECTION VIEW B - B

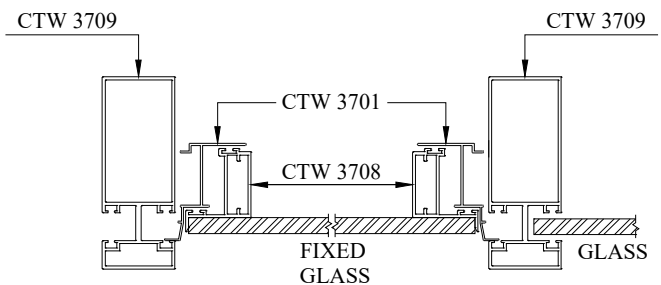

SECTION VIEW C - C



BP Aluminium Extrusion Sdn. Bhd.

No.15 & 16, 1C KKIP Selatan, Industrial Zone 2, KKIP,
88450, Jalan Sepanggar, Menggatal.

t : 60-88-499333, 499111 f : 60-88-499222

b_p_a_e@yahoo.com